

STEREO INTEGRATED AMPLIFIER

A-500

SERVICE MANUAL

FRONT PANEL

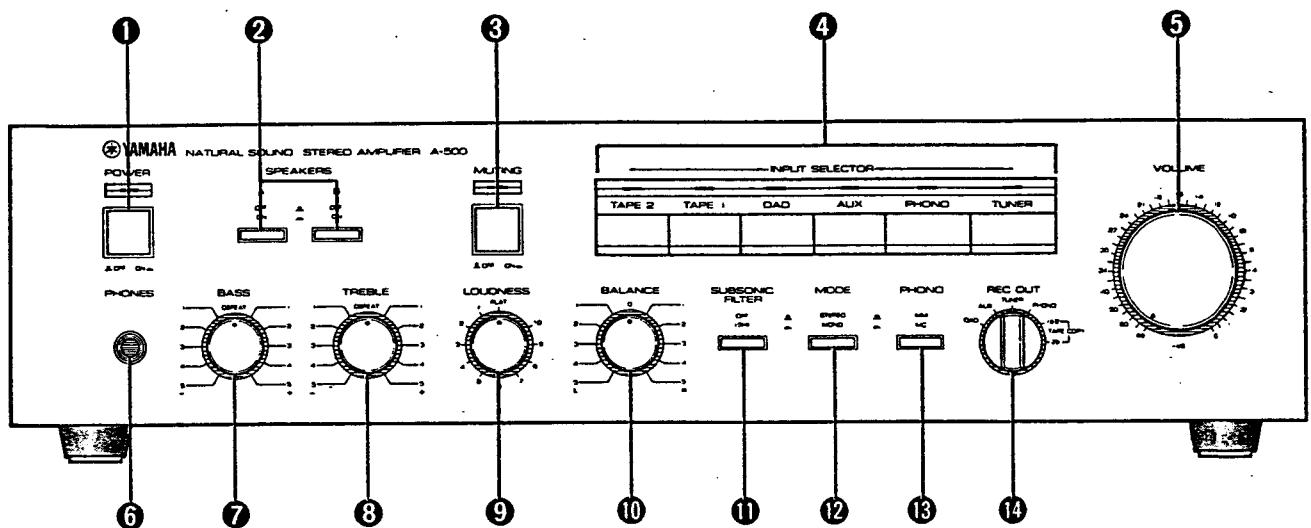

- ① POWER SWITCH
- ② SPEAKER SELECT SWITCHES
- ③ AUDIO MUTING SWITCH
- ④ INPUT SELECTORS
- ⑤ VOLUME CONTROL
- ⑥ HEADPHONES JACK
- ⑦ BASS CONTROL
- ⑧ TREBLE CONTROL
- ⑨ LOUDNESS CONTROL
- ⑩ BALANCE CONTROL
- ⑪ SUBSONIC FILTER
- ⑫ MODE SWITCH
- ⑬ PHONO SELECTOR
- ⑭ REC OUT SELECTOR

CONTENTS

TO SERVICE PERSONNEL	1
SPECIFICATIONS	1
REAR PANELS	2
INTERNAL VIEW	3
DISASSEMBLY PROCEDURES	3/4
ADJUSTMENTS	5
BLOCK DIAGRAM	5
PRINTED CIRCUIT BOARD	6
WIRING DIAGRAM	7
SCHEMATIC DIAGRAM	8

O04487

SINCE 1887



YAMAHA

NIPPON GAKKI CO., LTD. HAMAMATSU, JAPAN

11.8: 2.6k

TO SERVICE PERSONNEL

(Prepared in accordance with UL Standard 1270)

Before service of this appliance by you, please carefully read this service manual.

Please make Leakage-current or Resistance measurements by suitable meter to determine that exposed parts are acceptably insulated from the supply circuit before returning the appliance to the customer.

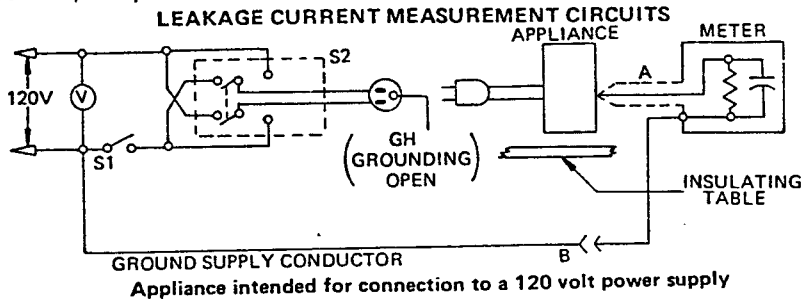

- A PROBE WITH SHIELDED LEAD.
 - B SEPARATED AND USED AS CLIP WHEN MEASURING CURRENTS FROM ONE PART OF APPLIANCE TO ANOTHER.
- Confirm that the leakage current is not more than 0.5mA

SPECIFICATIONS

Continuous Power Per Channel		
20Hz ~ 20kHz		
(0.01% THD, 8Ω)		70W
1kHz (0.01% THD, 8Ω)		75W
DIN Standard Output Power		
Per Channel		
1kHz (1% THD, 8Ω)		75W (G)(B)(A)
Power Bandwidth		
0.03% THD 35W (8Ω)		10Hz ~ 50kHz
Damping Factor		
1kHz 8Ω		better than 50
Input Sensitivity/Impedance		
Phono	MC	160μV/100Ω
	MM	2.5mV/47kΩ
Aux, Tape, Tuner		150mV/47kΩ
Input Sensitivity (New IHF)		
Phono	MC	19μV
	MM	0.3mV
Aux, Tape, Tuner		18mV
Maximum Input Signal		
0.01% THD Phono	MC	10mV
	MM	150mV
Output Level/Impedance		
Rec Out		150mV/470Ω
Headphone Jack Rated Output/Impedance		
0.01% THD 8Ω		0.68V/270Ω
Frequency Response		
Aux, Tape, Tuner		20Hz ~ 20kHz, ±0.5dB
RIAA Equalization Deviation		
Phono	MC	±0.3dB
	MM	±0.2dB
Total Harmonic Distortion		
Phono MC to Rec Out (3V)		0.007%
MM to Rec Out (3V)		0.003%
Aux, Tape, Tuner to Sp Out (1W/8Ω)		0.005%
Intermodulation Distortion		
Aux, Tape, Tuner Rated Output/8Ω	1W/8Ω	0.01%
		0.005%
Signal-to-Noise Ratio		
(IHF-A-Network)		
Phono MC (500μV Input Shorted)		76dB
MM (5mV Input Shorted)		92dB
Aux, Tape, Tuner (5.1kΩ)		100dB

Signal-to-Noise Ratio (New IHF)		
Phono	MC	74dB
	MM	78dB
Aux, Tape, Tuner		84dB
Residual Noise (IHF-A-Network)		140μV
Channel Separation		
Phono MM Input Shorted 1kHz		55dB
Aux, Tape 5.1kΩ 1kHz		60dB
Tone Control Characteristics		
Bass boost/cut		±10dB (at 20Hz)
Bass turnover frequency		350Hz
Treble boost/cut		±10dB (at 20kHz)
Treble turnover frequency		3.5kHz
Filter Characteristics		
Low (Subsonic)		15Hz -12dB/oct
Continuous Loudness Control		
(Level-related equalization)		
Attenuation		20dB (at 1kHz)
Audio Muting		-20dB
Gain Tracking Error (0 to -60dB)		2dB
Power Supply		
U.S.A. & Canadian models		AC 120V, 60Hz
General model		AC 110/120/220/240V, 60/50Hz
British and Australian models		AC240V, 50Hz
European model		AC220V, 50Hz
Power Consumption		275W/380W (G)(B)(A)
AC Outlet		
Switched x 2		200W max.
Unswitched x 1		200W max.
Dimensions (W x H x D)		435 x 112 x 327mm (17-1/8x4-2/5x12-7/8)"
Weight		7.3kg (16.1 lbs)

(A) Australian model

(G) North European model only.

(B) British model only.

* Specifications subject to change without notice.

REAR PANELS

▼ U.S.A. & CANADIAN MODELS

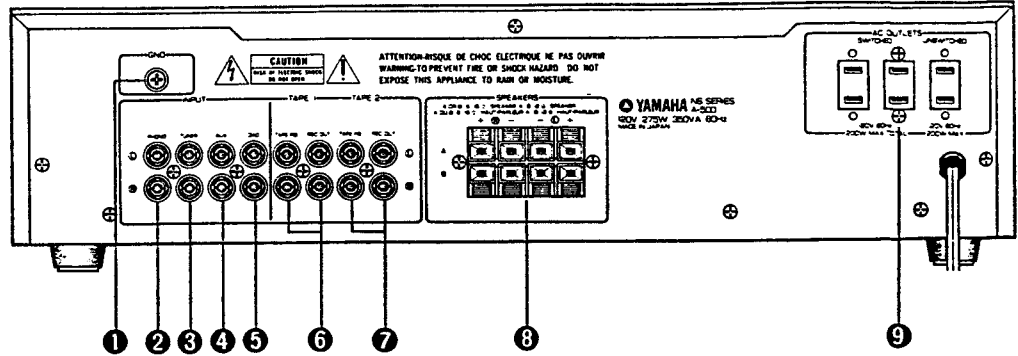

▼ GENERAL MODEL

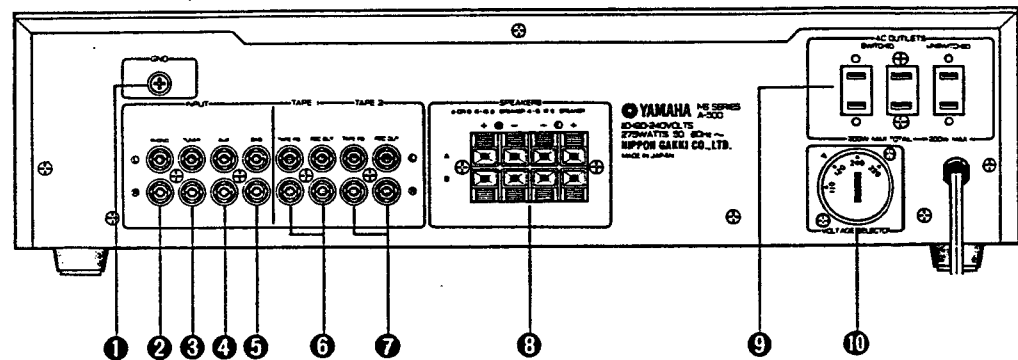

▼ BRITISH & AUSTRALIAN MODELS

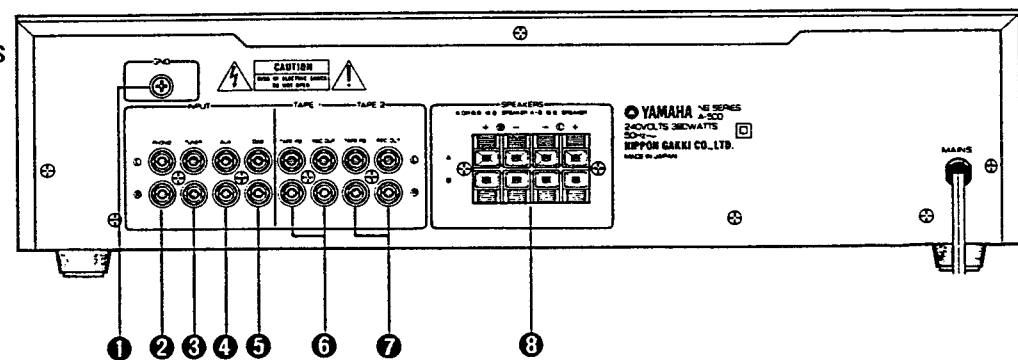

▼ EUROPEAN MODEL

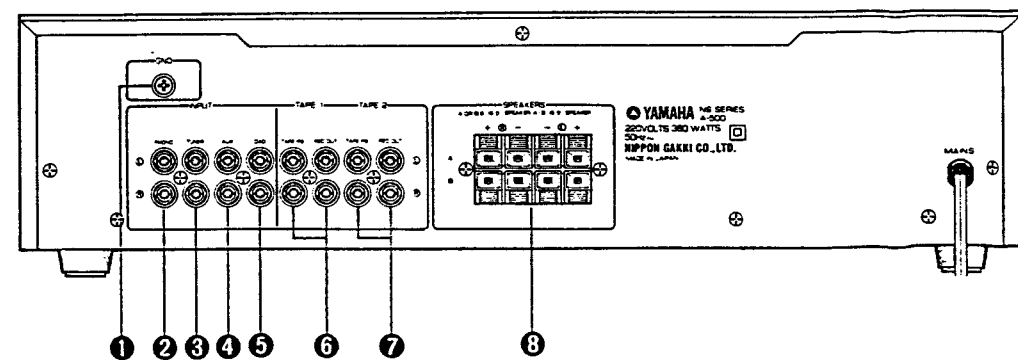

- | | |
|---|--|
| <ul style="list-style-type: none"> ① GND TERMINAL ② PHONO INPUT JACKS ③ TUNER INPUT JACKS ④ AUX INPUT JACKS ⑤ DIGITAL AUDIO DISK INPUT JACKS | <ul style="list-style-type: none"> ⑥ TAPE 1 PB/REC OUT JACKS ⑦ TAPE 2 PB/REC OUT JACKS ⑧ SPEAKER TERMINAL ⑨ AC OUTLETS ⑩ VOLTAGE SELECTOR |
|---|--|

INTERNAL VIEW

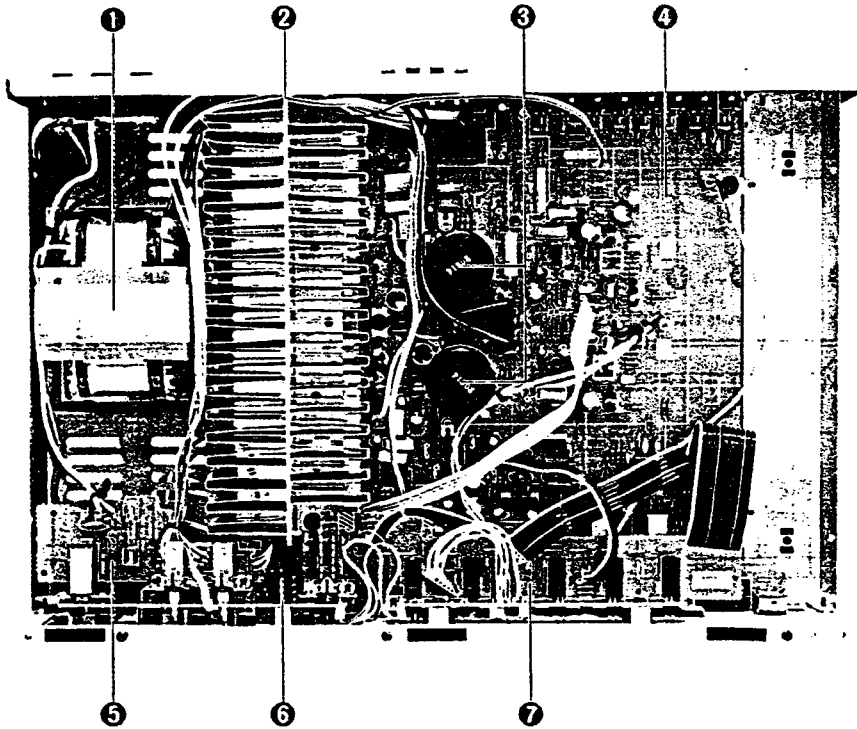

- 1 POWER TRANSFORMER
 - U.S.A. model : GA66220
 - Canadian model : GA66230
 - North European model : GA66250
 - British & Australian models : GA66260
 - General model : GA66240
- 2 HEAT SINK
- 3 ELECTROLYTIC CAPACITOR
(1200 μ F, 56V: FZ00371)
- 4 MAIN CIRCUIT BOARD
- 5 POWER SWITCH CIRCUIT BOARD
- 6 TONE VR CIRCUIT BOARD
- 7 INPUT SELECTOR CIRCUIT BOARD

DISASSEMBLY PROCEDURES

1. TOP COVER removal

Remove screws ① through ⑤ in Fig. 1 and then remove the top cover.

2. BOTTOM COVER removal

Remove screws ① through ⑤ in Fig. 2 and then remove the bottom cover.

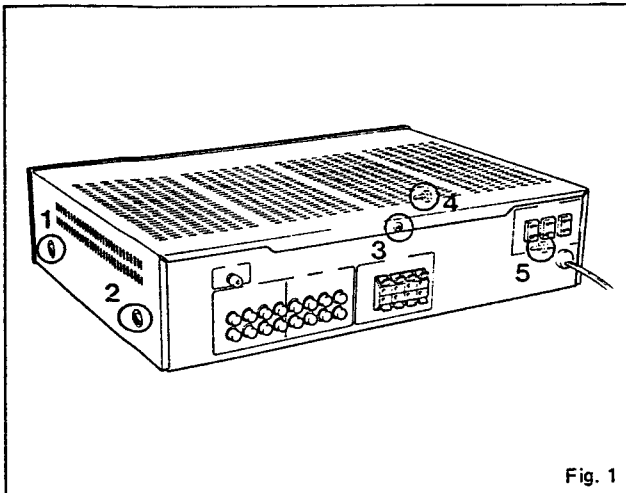

Fig. 1

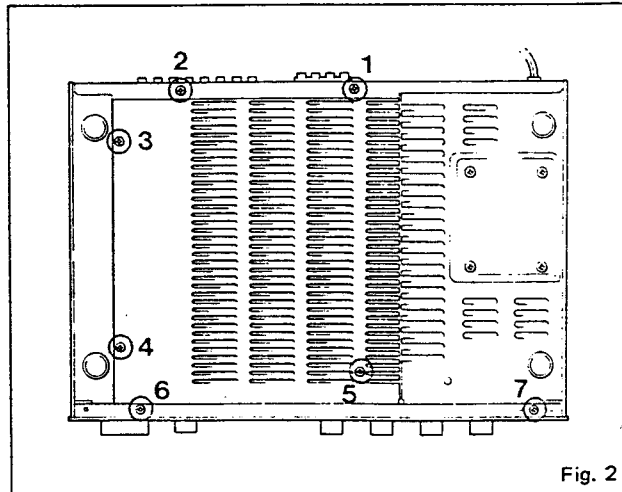

Fig. 2

3. FRONT PANEL removal

- a) Remove each knob by pulling forward.
- b) Remove screws ⑥ and ⑦ in Fig. 2 and screws ① through ③ in Fig. 3 and then remove the front panel.

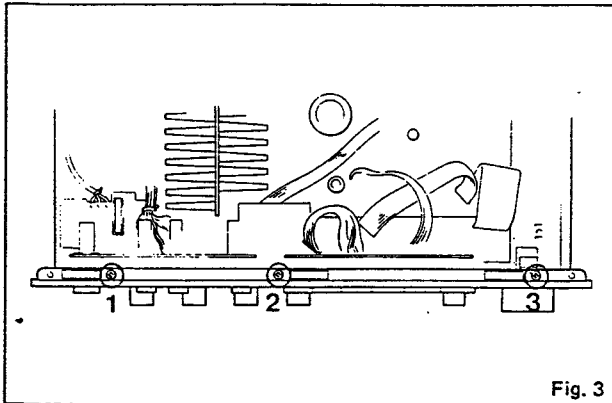

Fig. 3

4. INPUT SELECTOR circuit board removal

Remove screws ① through ④ in Fig. 4 and then remove the input selector circuit board.

5. POWER SWITCH circuit board removal

Remove screws ⑤ through ⑧ in Fig. 4 and then remove the power switch circuit board.

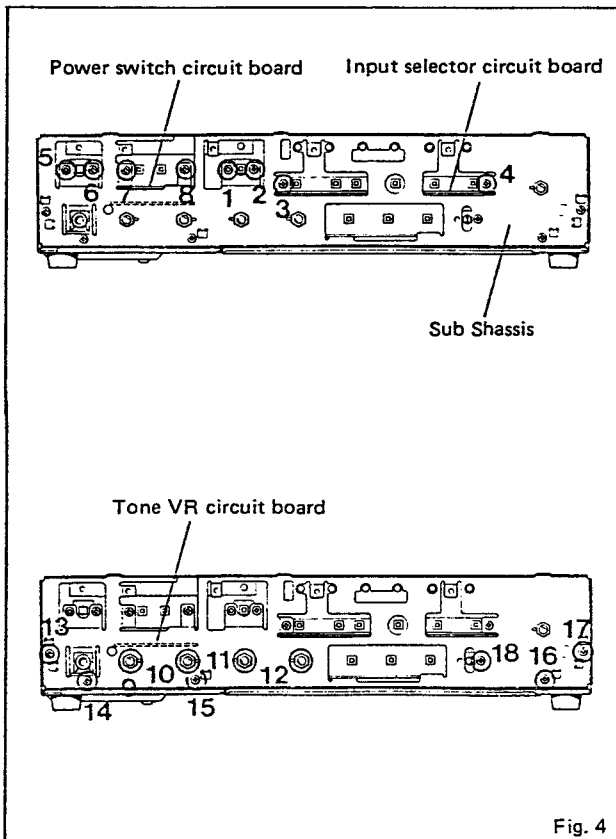

Fig. 4

6. TONE CONTROL VR replacement

- a) Remove the power switch circuit board.
- b) Remove hexagonal nuts ⑨ and ⑩ in Fig. 4. Remove the tone VR circuit board and then replace the VR.

7. BALANCE, LOUDNESS VR replacement

- a) Remove the input selector circuit board.
- b) Remove hexagonal nuts ⑪ and ⑫ in Fig. 4.
- c) Remove screws ⑬ through ⑱ in Fig. 4 and then remove the sub shassis.
- d) Detach the soldering of the VR and then replace the balance, loudness VR.

ADJUSTMENTS

● IDLING CURRENT adjustment

After the power switch is pushed on, wait 3 ~ 4 minutes before measuring, to be sure of the most stable operation. With no signal input, rotate VR107 (Lch) and VR108 (Rch) so that the voltage between TP1 and TP2 (Lch) and between TP3 and TP4 (Rch) comes to $15\text{mV} \pm \frac{5}{3}\text{mV}$.

	Test points	Adjustment points	Rating
Lch	TP1 ~ TP2	VR107	$15\text{mV} \pm \frac{5}{3}\text{mV}$
Rch	TP3 ~ TP4	VR108	$15\text{mV} \pm \frac{5}{3}\text{mV}$

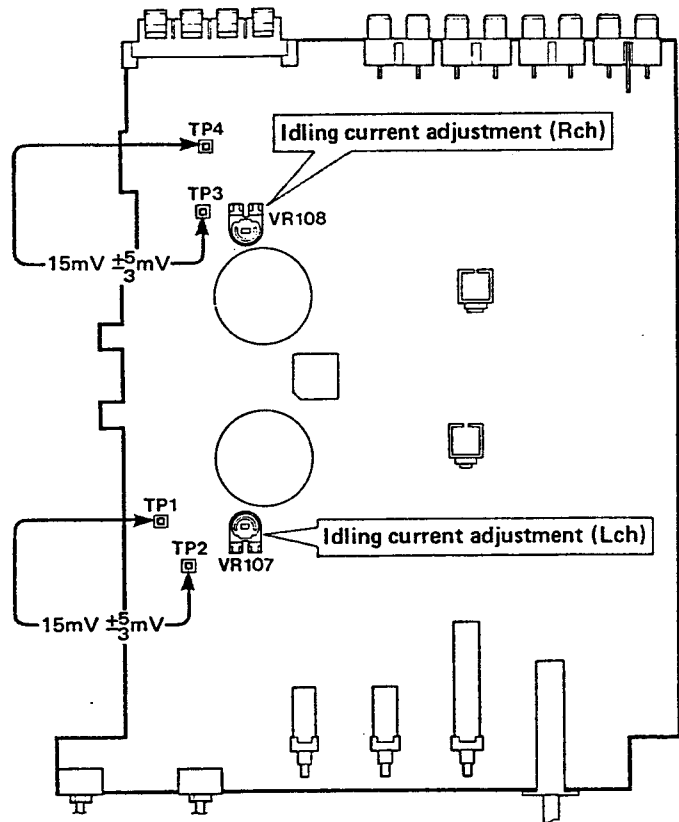

BLOCK DIAGRAM

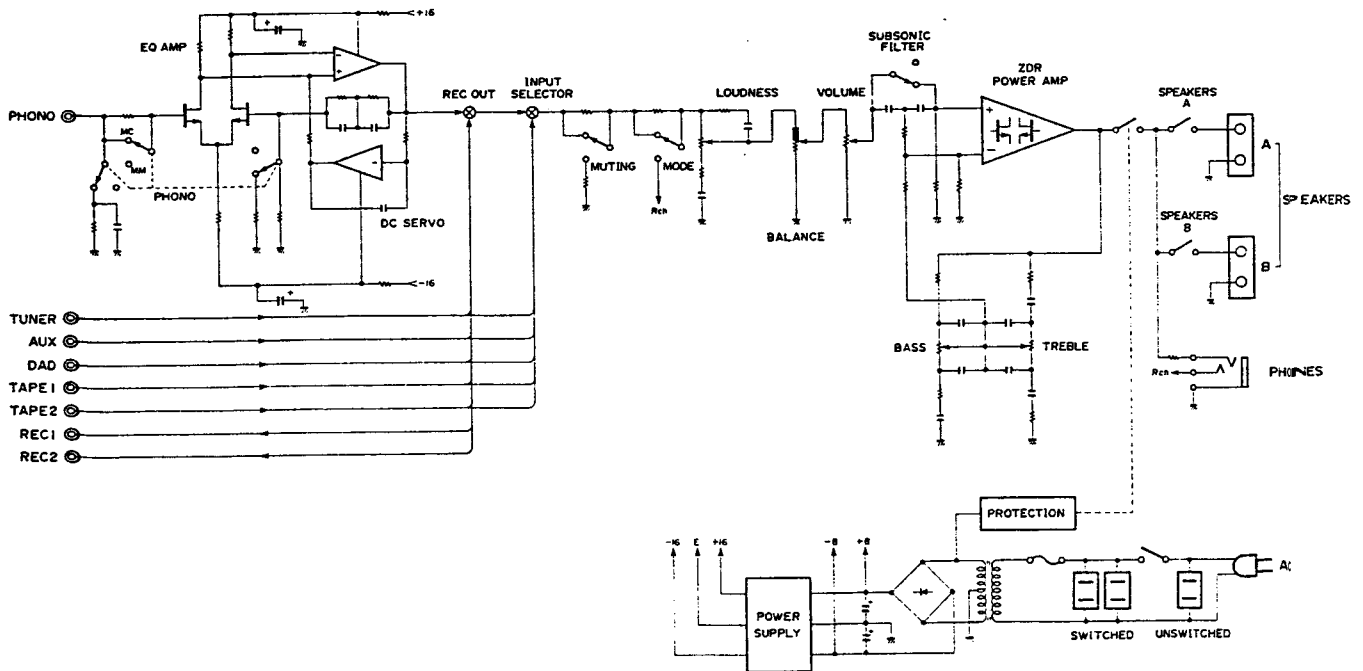

A

B

C

D

E

F

G

PRINTED CIRCUIT BOARD (Pattern Side)

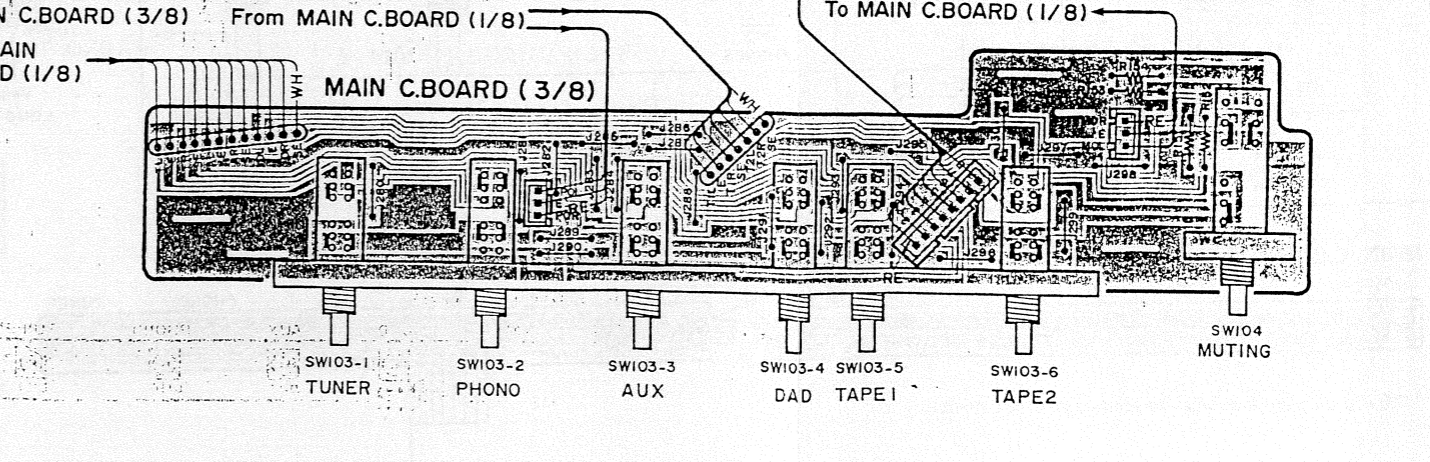
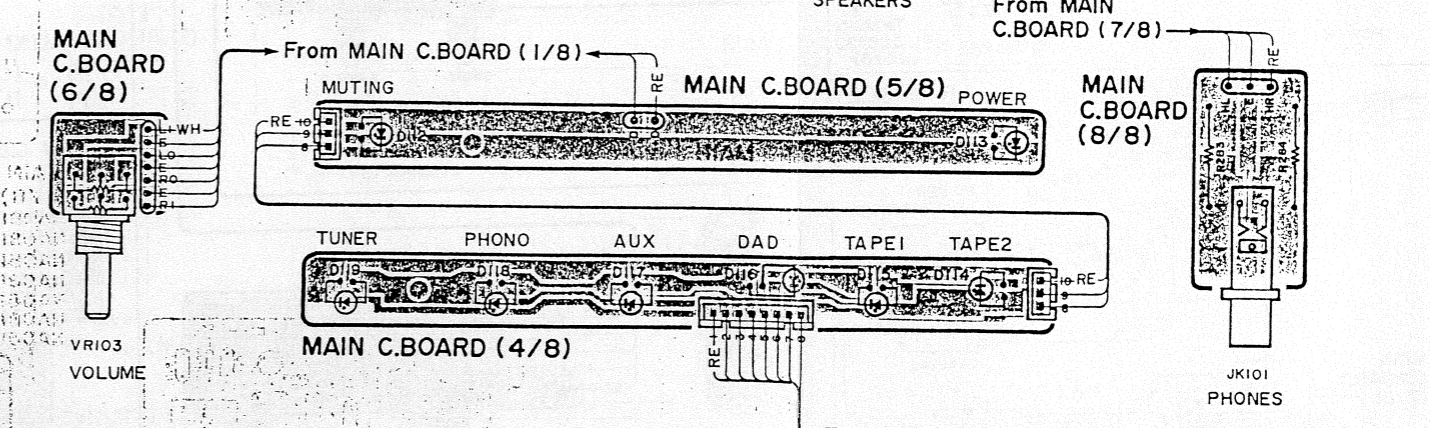
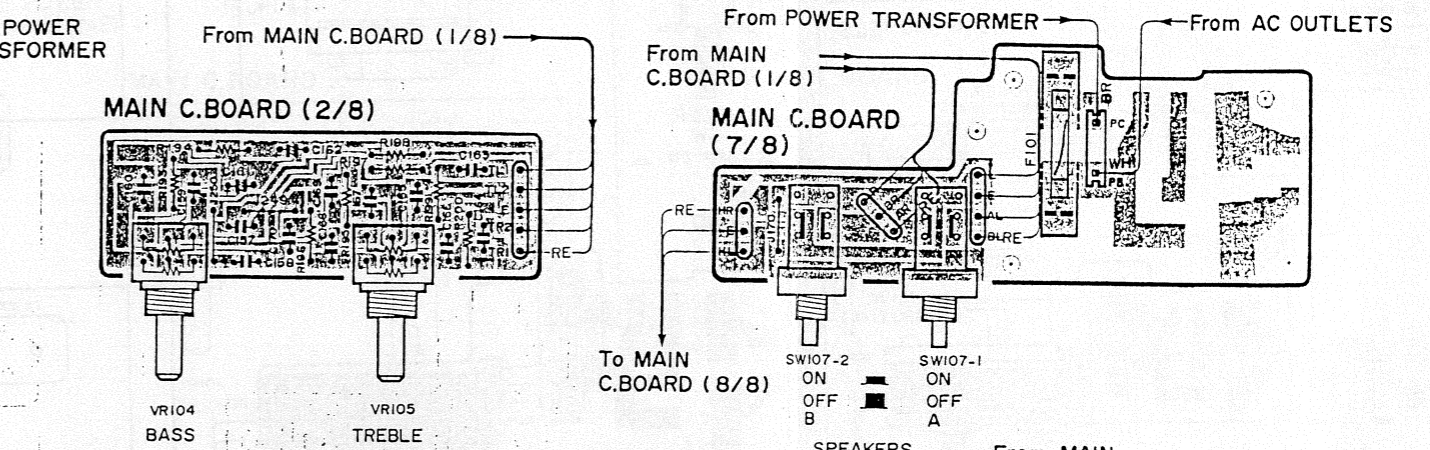
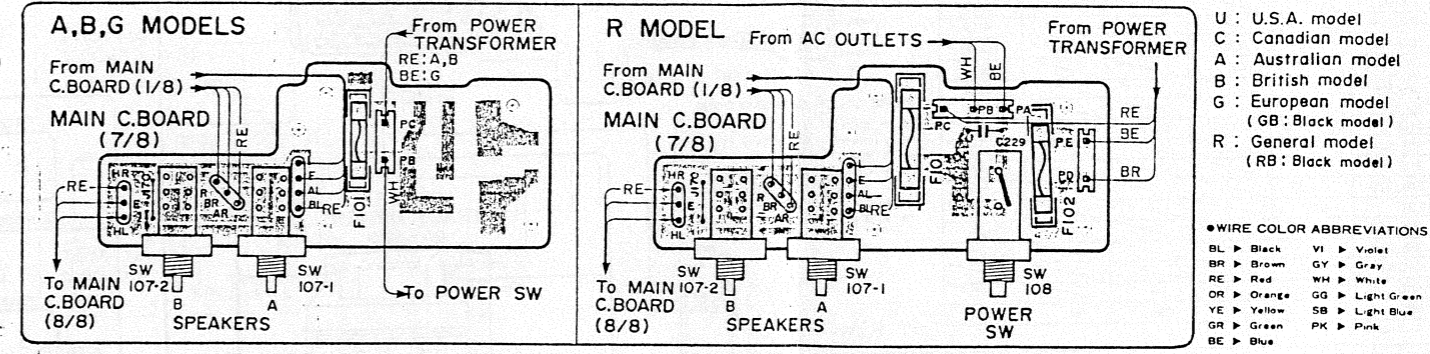
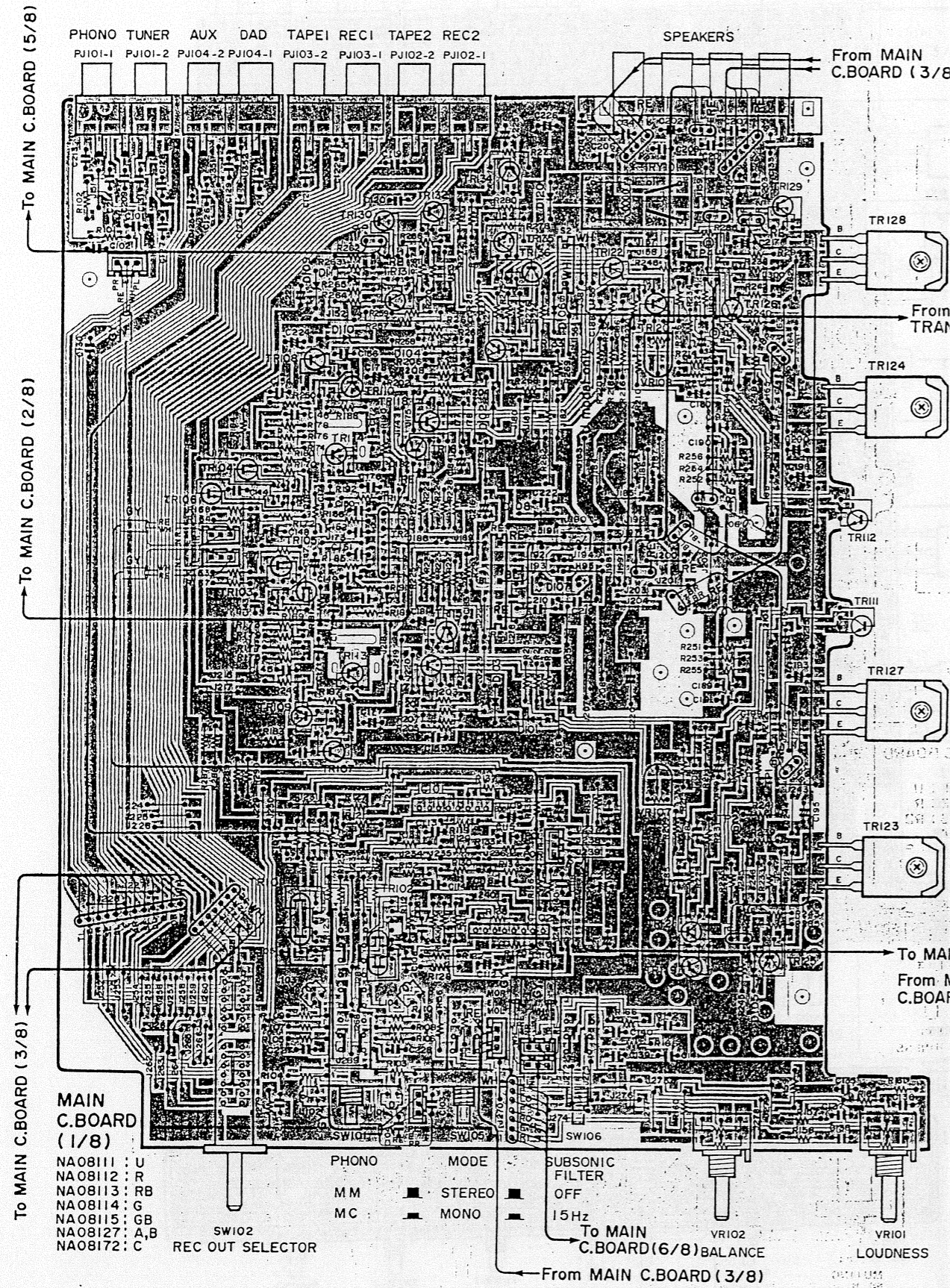

6

WIRING DIAGRAM (Parts Side)

	R	U	C	A, B	G
R101,102	10	10	10	10	33
R103,104					470
R109,110	33	33	33	33	2.2k
R279					4.7
R291		3P12k	3P1.2k		
C101,102					150P
C103,104					47P
C105,106	220P	220P	220P	220P	100P
C119-128					330P
C131,134					0.022
C201-208					4700P
C210	0.01/500	0.01/500	0.01/500	0.01/500	
C213,214					100P
C215					0.1/25
C218,219					0.047/100
C229	0.01				
L101,102					15μH
L103,104					220μH
SW108	Set				
FI02	T3.5A250V				
J381	Set				

U : U.S.A. model
 C : Canadian model
 A : Australian model
 B : British model
 G : European model (GB:Black model)
 R : General model (RB:Black model)

WIRE COLOR ABBREVIATIONS
 BL ▶ Black VI ▶ Violet
 BR ▶ Brown GY ▶ Gray
 RE ▶ Red WH ▶ White
 OR ▶ Orange GG ▶ Light Green
 YE ▶ Yellow SB ▶ Light Blue
 GR ▶ Green PH ▶ Pink
 BE ▶ Blue

U,C MODEL
 AC OUTLETS
 UN SWITCHED SWITCHED

POWER TRANSFORMER
 GA 66210

SPEAKERS

REC2 TAPE2 REC1 TAPE1 DAD AUX TUNER PHONO
 PJ102-1 PJ102-2 PJ103-1 PJ103-2 PJ104-1 PJ104-2 PJ101-2 PJ101-1

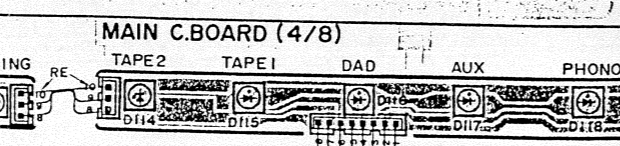
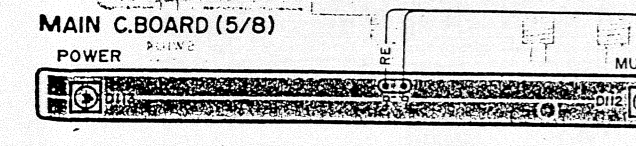
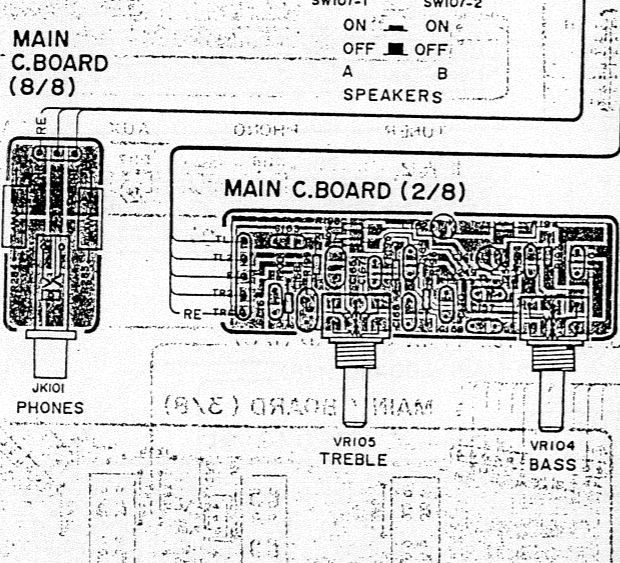
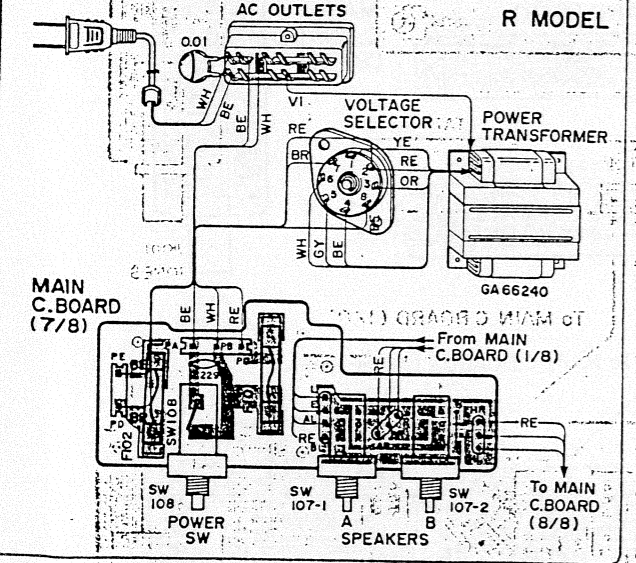
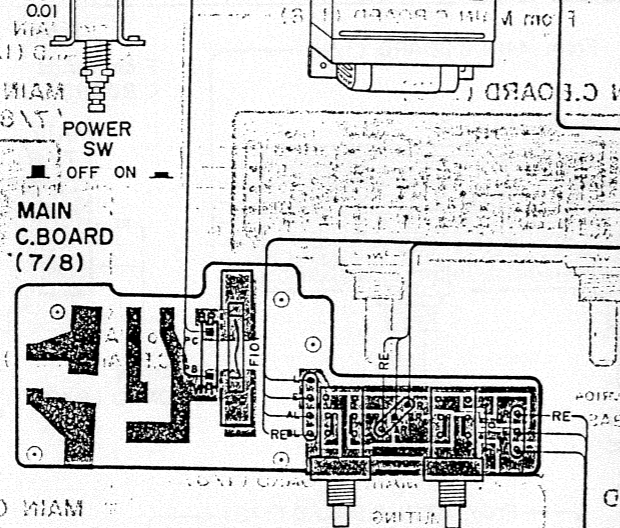
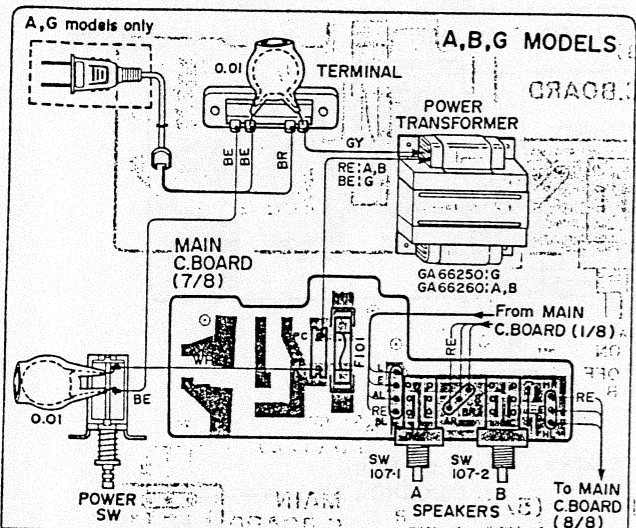

MAIN C.BOARD (1/8)
 NA08111 : U
 NA08112 : R
 NA08113 : RB
 NA08114 : G
 NA08115 : GB
 NA08127 : A,B
 NA08172 : C

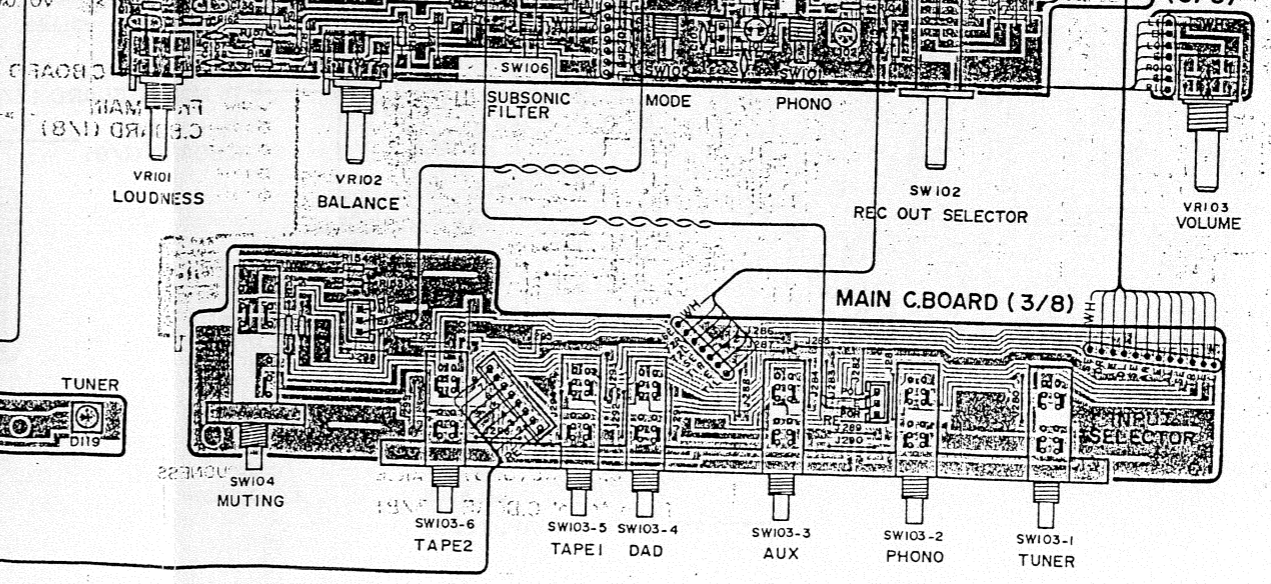

* Wiring diagram is subject to change without notice.

SCHEMATIC DIAGRAM

MAIN 1

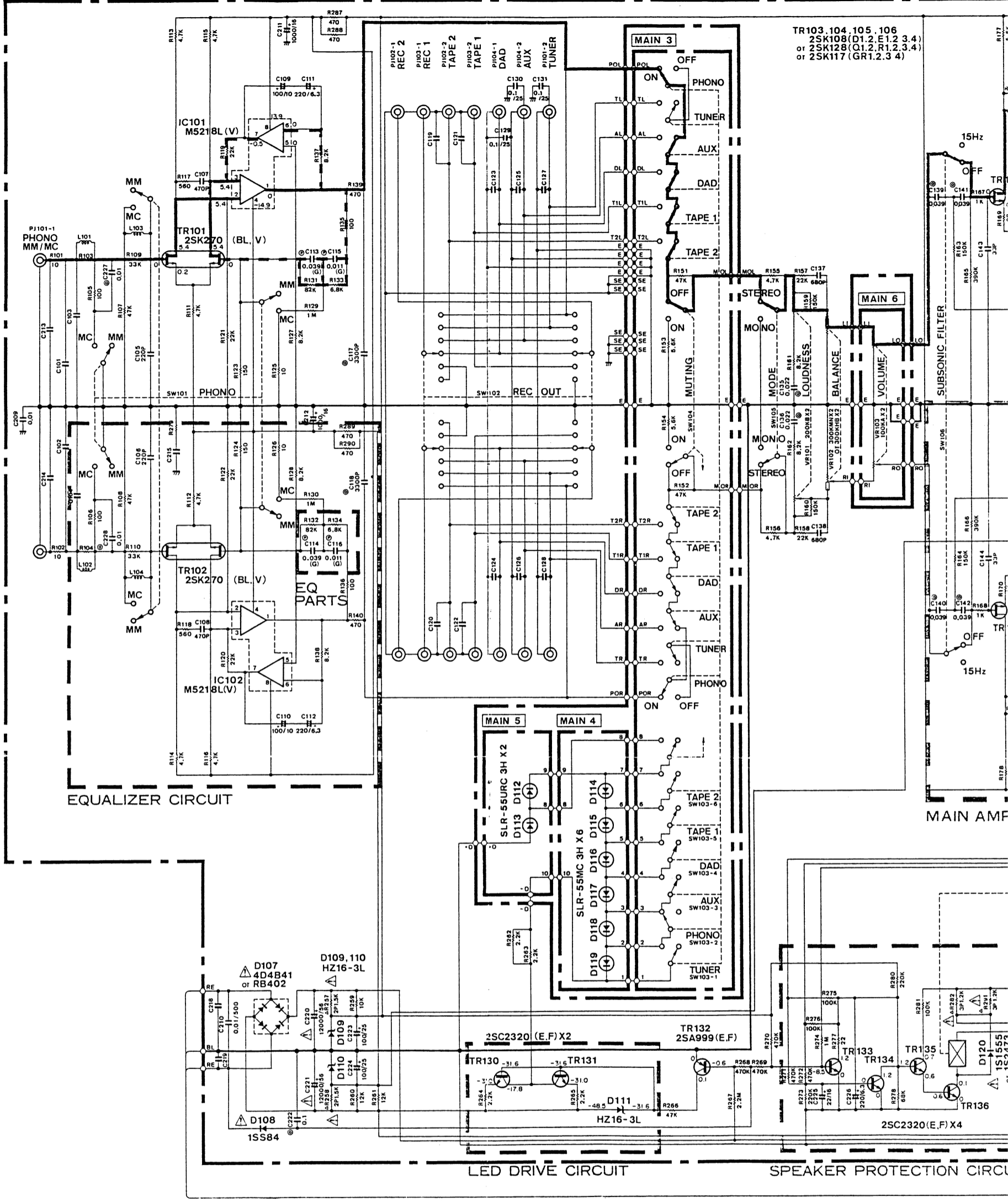

WARNING

⚠ Marked: Critical components by UL Standard 1270. Replace only with same type parts.

* All voltages are measured with a 10MΩ/DC electric volt meter.

* Schematic diagram is subject to change without notice.

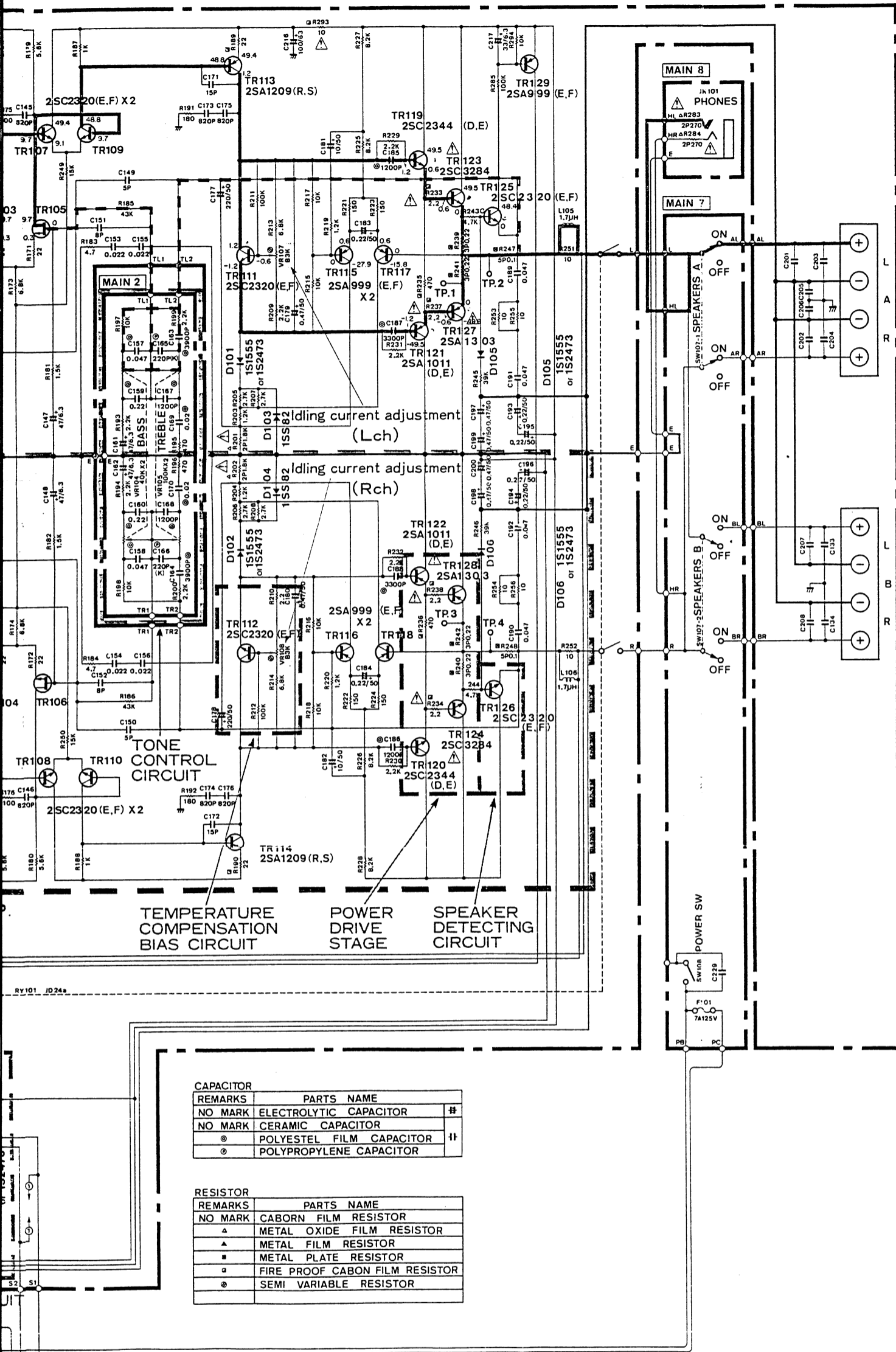

This schematic diagram is for U.S. model. The following parts and values differ from each model, so refer to the corresponding column.

	R	U	C	A, B	G
C101, 102					150p
C103, 104					47p
C105, 106	220p	220p	220p	220p	100p
C119 ~ 128					330p
C133, 134					0.022
C201, 202					4700p
C203 ~ 206					0.022
C207, 208					4700p
C210	0.01/500	0.01/500	0.01/500	0.01/500	
C213, 214					100p
C215					0.1/25
C218, 219					0.047/100
C229	0.01				
L101, 102					15μH
L103, 104					220μH
R101, 102	10	10	10	10	33
R103, 104	Short	Short	Short	Short	470
R109, 110	33	33	33	33	2.2k
R141 ~ 150	Short	Short	Short	Short	2.2k
R279					4.7
R291		1.2k 3p	1.2k 3p		
F101	T7.0A 250V	7A 125V	7A 125V	T3.15A 250V	T3.15A 250V
F102	T3.5A 250V				
RY101	JD24V	JC2a	JC2a	JD24V	JD24V
SW108	Set				
⊖	Short	Open	Short	Short	Short

General model

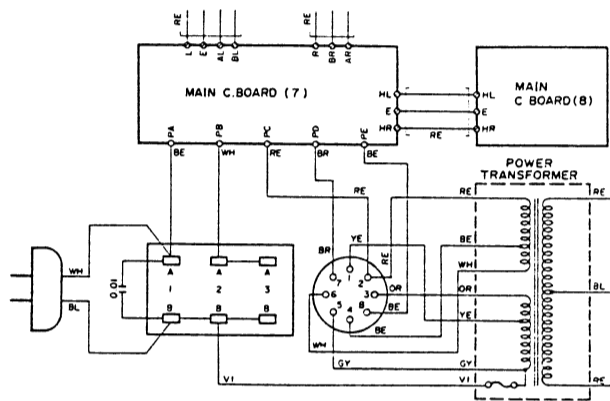

European model

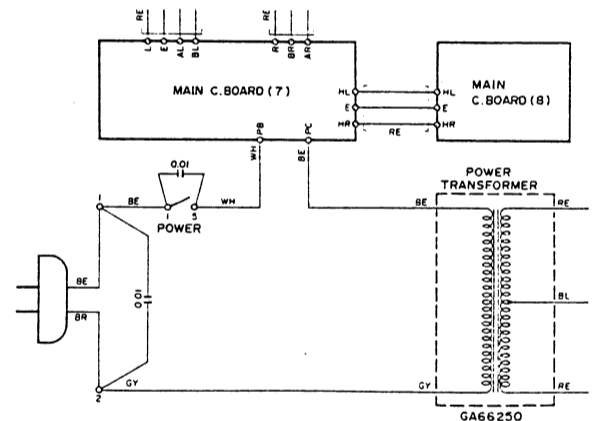

British & Australian models

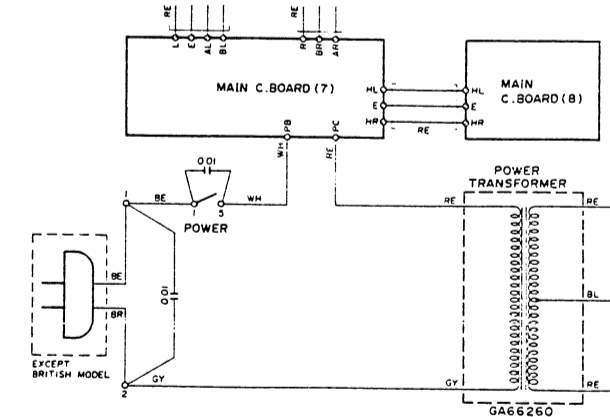

CAPACITOR	
REMARKS	PARTS NAME
NO MARK	ELECTROLYTIC CAPACITOR #
NO MARK	CERAMIC CAPACITOR #
⊙	POLYESTEL FILM CAPACITOR #
⊙	POLYPROPYLENE CAPACITOR #

RESISTOR	
REMARKS	PARTS NAME
NO MARK	CARBON FILM RESISTOR
△	METAL OXIDE FILM RESISTOR
▲	METAL FILM RESISTOR
■	METAL PLATE RESISTOR
□	FIRE PROOF CARBON FILM RESISTOR
⊙	SEMI VARIABLE RESISTOR

* is used only for U.S.A. model

IC BLOCK & SCHEMATIC DIAGRAM

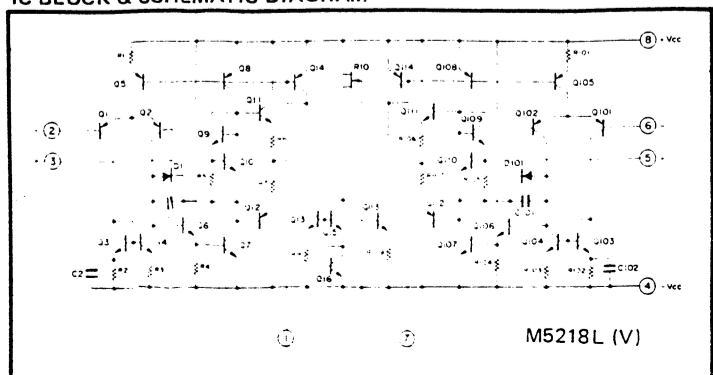

PIN CONNECTION DIAGRAM OF TRANSISTORS, DIODES AND ICs.

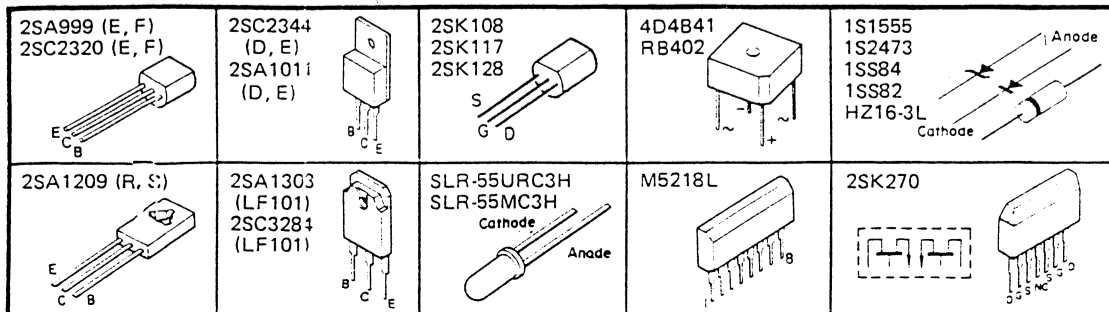

PARTS LIST

A-500

STEREO AMPLIFIER

■CONTENTS	Page.
MECHANISM CHASSIS UNIT	1
PARTS LIST (MECHANISM CHASSIS UNIT)	2
PARTS LIST (ELECTRICITY)	4

■MARKET	
U	USA MODEL
C	CANADIAN MODEL
A	AUSTRALIAN MODEL
G	EUROPEAN MODEL
B	BRITISH MODEL
R	GENERAL MODEL

SINCE 1887



YAMAHA

NIPPON GAKKI CO., LTD. HAMAMATSU, JAPAN

004487

'82,12 2.65K ①

MECHANISM CHASSIS UNIT

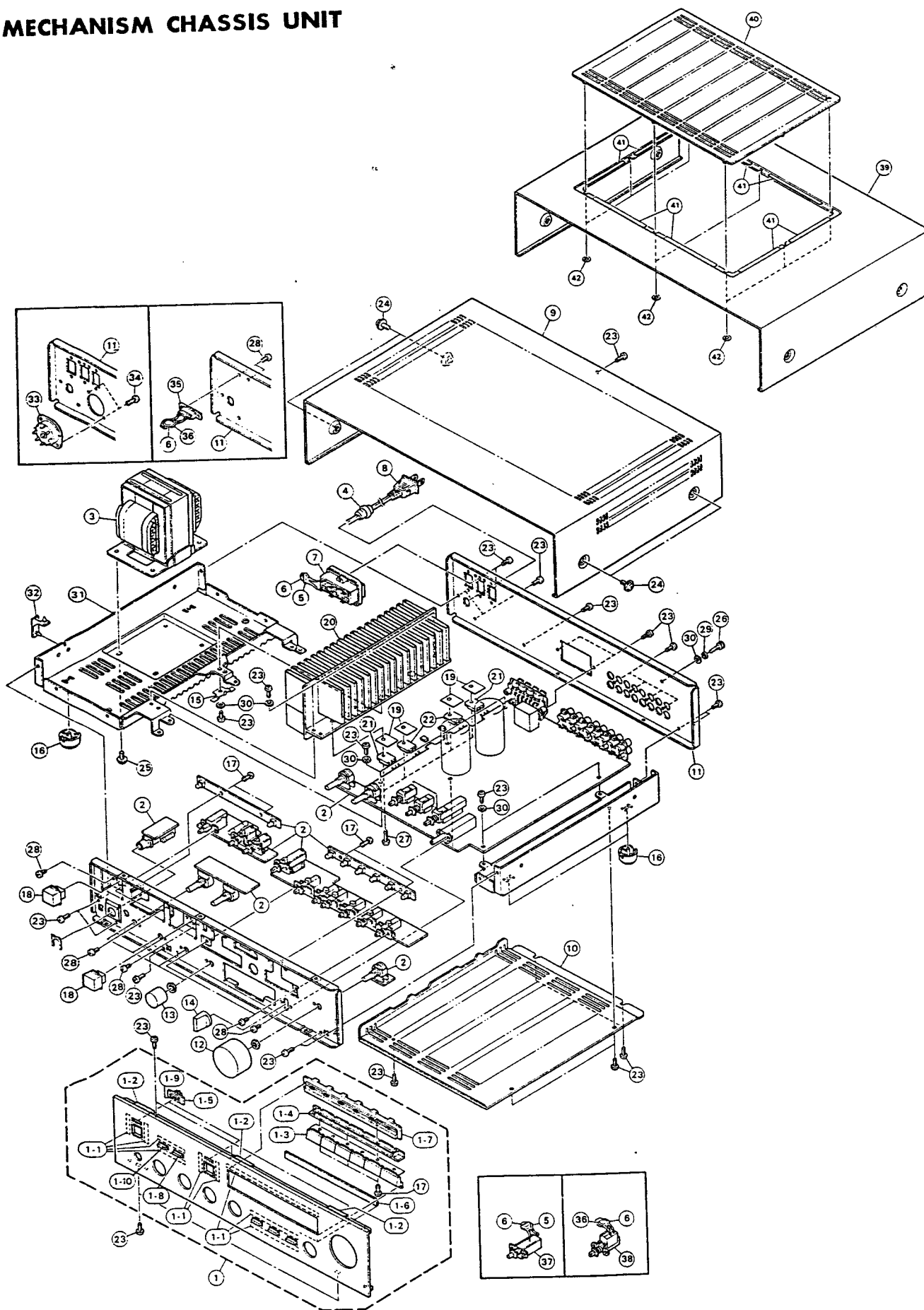

■PARTS LIST(MECHANISM CHASSIS UNIT)

REF. NO.	PART NO.	DESCRIPTION	部 品 名	REMARKS	MARKET
※ 1	N B 610290	PANEL UNIT	パネルユニット	SILVER	J.R.U.W.A.E.G.C.B
※ 1	N B 610300	PANEL UNIT	パネルユニット	BLACK	RB. GB. U. B. C
※ 1-2	C B 610350	ANTI-VIBRATION RUBBER	防振ゴム		
※ 1-3	N B 610190	KNOB ASS'Y	ツマミASS'Y	SILVER	J.R.U.A.G.C.B
※ 1-3	N B 610630	KNOB ASS'Y	ツマミASS'Y	BLACK	RB. GB. BB. U. C
※ 1-4	C B 616040	HOLDER LENS	レンズホルダー		J.R.U.A.G.C.B
※ 1-5	C B 616030	LENS FLEME	レンズ枠	SILVER	
※ 1-5	C B 616680	LENS FLAME	レンズ枠	BLACK	
※ 1-6	C B 618790	SW DAMPER	SWダンパー		
※ 1-7	C B 616050	INDICATOR PANEL	インジケーターパネル	SILVER	J.R.U.A.G.C.B
※ 1-7	C B 616690	INDICATOR PANEL	インジケーターパネル	BLACK	RB. GB. U. B. C
※ 1-8	C B 606450	FLAME P. BUTTON	ボタン枠(P)	SILVER	J.R.U.A.G.C.B
※ 1-8	C B 610280	FLAME P. BUTTON	ボタン枠(P)	BLACK	RB. GB. BB. U. C
※ 1-9	C B 616020	LENS	レンズ		
※ 1-10	N B 604260	PUSH BUTTON ASS'Y	プッシュボタンASS'Y	SILVER	J.R.U.A.G.C.B
※ 1-10	N B 610650	PUSH BUTTON ASS'Y	プッシュボタンASS'Y	BLACK	R. G. B. U. C
※ 2	N A 081110	MAIN CIRCUIT BOARD	メインシート		U
※ 2	N A 081120	MAIN CIRCUIT BOARD	メインシート		R
※ 2	N A 081130	MAIN CIRCUIT BOARD	メインシート	BLACK	RB
※ 2	N A 081140	MAIN CIRCUIT BOARD	メインシート		G
※ 2	N A 081150	MAIN CIRCUIT BOARD	メインシート	BLACK	GB
※ 2	N A 081270	MAIN CIRCUIT BOARD	メインシート		A. B
※ 2	N A 081720	MAIN CIRCUIT BOARD	メインシート		C
※ 2	N A 082160	MAIN CIRCUIT BOARD	メインシート	BLACK	U
※ 2	N A 082170	MAIN CIRCUIT BOARD	メインシート	BLACK	C
※ 3	G A 662200	POWER TRANSFORMER	電源トランス		U
※ 3	G A 662300	POWER TRANSFORMER	電源トランス		C
※ 3	G A 662500	POWER TRANSFORMER	電源トランス		G.
※ 3	G A 662600	POWER TRANSFORMER	電源トランス		A. B
※ 3	G A 662400	POWER TRANSFORMER	電源トランス		R
※ 4	C B 072750	CORD STOPPER	コードストッパー		J.R.U.A.G.C.B
※ 5	C B 600810	CONDENSER COVER	HY-0102 コンデンサカバー半丸型		R.U.C.R.B
※ 6	F I 384100	CERAMIC CAP.	0.01 μ F セラコン		
※ 7	L B 603920	AC OUTLET (3 SOCKET)	M7026-C AC,アウトレット3連		R. U
※ 7	L B 604230	AC OUTLET (3 SOCKET)	M7026-C AC,アウトレット3連		C
※ 8	M G 000780	AC CORD (BLACK)	2m 6A 電源コード		R
※ 8	M G 000920	AC CORD (GRAY)	2.5m 7.5A 電源コード		A
※ 8	M G 000950	AC CORD (GRAY)	2m 2.5A 電源コード		G
※ 8	M G 001000	AC CORD (BLACK)	2m 6A 電源コード		B
※ 8	M G 001450	AC CORD (BLACK)	1.98m 10A 電源コード		U. C
※ 9	A A 614600	TOP COVER	トップカバー		R. U. A. C. R
※ 9	A A 615090	TOP COVER	トップカバー	BLACK	R. U. C
※ 10	A A 614630	BOTTOM COVER	ボトムカバー		
※ 11	A A 614670	REAR PANEL	リヤパネル		R
※ 11	A A 614680	REAR PANEL	リヤパネル		U. C
※ 11	A A 614690	REAR PANEL	リヤパネル		G
※ 11	A A 614700	REAR PANEL	リヤパネル		B
※ 12	B A 084890	KNOB, VOL	VOLツマミ		J.R.U.A.G.C.B
※ 12	B A 085090	KNOB, VOL	VOLツマミ	BLACK	R. U. C. GB

※ : New Parts (新規部品)

PARTS LIST (MECHANISM CHASSIS UNIT)

REF. NO.	PARTS NO.	DESCRIPTION	部 品 名	REMARKS	MARKET
13	B A 084900	KNOB, TC	TCツマミ		J. R. U. A. G. C. B
13	B A 085100	KNOB, TC	TCツマミ	BLACK	RB. GB. U. C
14	B A 084910	KNOB, SW	SWツマミ		J. R. U. A. G. C. B
14	B A 085110	KNOB, SW	SWツマミ	BLACK	RB. GB. U. C
15	B B 070120	TR PUSHER	TRブッシャー		
16	C B 610390	LEG	脚		
17	C B 068880	PLASTIC RIVET	プラスチックリベット		J. R. U. A. G. C
18	N B 609160	BUTTON (P) ASS'Y	ボタン (P) ASS'Y		J. R. U. A. G. C. B
18	N B 609170	BUTTON (P) ASS'Y	ボタン (P) ASS'Y	BLACK	RB. GB. BB. U. C
19	I L 000570	MICK BASE	MT-100 マイカベース		
20	B A 084610	HEAT SINK	放熱板		
21	I X 600640	TRANSISTOR	2SC3284 トランジスタ		
22	I X 600630	TRANSISTOR	2SA1303 トランジスタ		
23	E I 330086	BIND TAPPING SCREW	3×8 FCM3-BL バインドタッピングネジ2種	1PACK	
24	E Z 001310	CUP-TIGHT SCREW	4×8 3G カップタイトネジ (S)	SILVER	
25	E K 135020	B.W HEAD TAPPING SCREW	4×10 φ10 BL BWヘッドタッピングネジ2種		
26	E Z 001400	GROUND TERMINAL SCREW O	⊕3×13.5 アース端子ネジ		
27	E I 330126	BIND TAPPING SCREW	3×12 BL バインドタッピングネジ		
28	E D 330066	BIND SCREW	3×6 FCM3-BL バインド小ネジ	1PACK	
29	EW403650	FLAT WASHER, SEMS TYPE	φ3.6t 0.8 平座金		
30	E V 203030	FLAT WASHER	φ3 BL 平座金		
31	A A 614640	SIDE FLAME (L)	サイドフレーム(L)		
32	C B 096510	LED SATND	LEDスタンド(L)		
33	L B 201480	VOLTAGE SELECTOR	0211 電圧切換器		
34	C B 068880	PLASTIC RIVET	プラスチックリベット		
35	L A 002950	TERMINAL 2P	2P端子板		A. G. C. GB
36	C B 095260	CONDENSER COVER	コンデンサーカバー		A. G. B. GB
37	K A 801230	POWER SW	SY10-1, TV-5 ブッシュSW		U. C
38	K A 802460	POWER SW	SS-13S ブッシュSW		A. G. B. GB
39	A A 614610	TOP COVER	トップカバー		G. B
39	A A 615040	TOP COVER	トップカバー	BLACK	G. B
40	C B 616700	HEAT GRILL	放熱グリル		G. B
40	C B 616710	HEAT GRILL	放熱グリル	BLACK	G. B
41	C B 074190	TAPE	5×45 セキスイダブルタックテープ		G. B. GB
42	E V 523500	STOP RING CS-TYPE	CSTW5 φ5 CS止メ輪		G
	C B 069250	BINDING TIE	インシュロックタイ		R. U. A. G. C. B. G. B. R. G
24	E Z 001320	CUP-TIGHT SCREW	4×8 BL カップタイトネジ	BLACK	

: New Parts (新規部品)

■PARTS LIST (ELECTRICITY)

REF. NO.	PARTS NO.	DESCRIPTION	部 品 名	REMARKS	MARKET	
	FG 410500	CERAMIC CAP.	5pF 50V	セラコン	C149. 150	
	FG 410800	CERAMIC CAP.	8pF 50V	セラコン	C151. 152	
	FG 411150	CERAMIC CAP.	15pF 50V	セラコン	C171. 172	
	FG 411330	CERAMIC CAP.	33pF 50V	セラコン	C143. 144	
	FG 411470	CERAMIC CAP.	47pF 50V	セラコン	C103. 104	G. GB
	FG 412100	CERAMIC CAP.	100pF 50V	セラコン	C213. 214	G. GB
	FG 412220	CERAMIC CAP.	220pF 50V	セラコン	C105. 106	J.R.U.A.G.C.B
	FG 412100	CERAMIC CAP.	100pF 50V	セラコン	C105. 106	G. B
	FG 412330	CERAMIC CAP.	330pF 50V	セラコン	C119-128	G. B
	FG 412470	CERAMIC CAP.	470pF 50V	セラコン	C107-108	
	FG 412680	CERAMIC CAP.	680pF 50V	セラコン	C137. 138	
	FG 412150	CERAMIC CAP.	150pF 50V	セラコン	C101. 102	G. GB
	FG 212820	CERAMIC CAP.	820pF 50V	セラコン	C145. 146 173-176	
	FG 413470	CERAMIC CAP.	4700pF 50V	セラコン	C201. 202. 207. 208	G. GB.
	FG 444100	CERAMIC CAP.	0.01 μ F 50V	セラコン	C209	
	FG 444220	CERAMIC CAP.	0.022 μ F 50V	セラコン	C153-156	
	FG 444220	CERAMIC CAP.	0.022 μ F 50V	セラコン	C133. 134 203-206	G. GB
	FG 444470	CERAMIC CAP.	0.047 μ F 50V	セラコン	C189-192	
	FI 414100	CERAMIC CAP.	0.01 μ F	セラコン	C229	R. RB
	FH 234100	CERAMIC CAP.	0.01 μ F	セラコン	C210	J.R.U.A.G.C.B
	FT 512220	POLYPROPYLENE CAPACITOR	220pF 50V	ポリプロコン	C165. 166	
*	UT 464110	POLYPROPYLENE CAPACITOR	0.011 μ F	ポリプロコン	C115. 116	
*	UT 464390	POLYPROPYLENE CAPACITOR	0.039 μ F	ポリプロコン	C113. 114	
*	FZ 003710	ELECTROLYTIC CAP.	12000 μ F	ブロックケミコン	C220. 221	
*	FZ 003790	CERAMIC CAP.	0.1 μ F 25V	セラコン	C129-131	
	FZ 003790	CERAMIC CAP.	0.1 μ F	セラコン	C215	G. GB
	FA 453120	MYLAR CAP.	1200pF	マイラーコン	C167. 168. 185. 186	
	UA 253330	MYLAR CAP.	0.0033 μ F 50V	マイラーコン	C117. 118. 187. 188	
	UA 253390	MYLAR CAP.	0.0039 μ F 50V	マイラーコン	C163. 164	
	UA 254100	MYLAR CAP.	0.01 μ F 50V	マイラーコン	C227. 228	
	UA 254200	MYLAR CAP.	0.02 μ F 50V	マイラーコン	C169. 170	
	UA 254220	MYLAR CAP.	0.022 μ F 50V	マイラーコン	C135. 136	
	UA 254390	MYLAR CAP.	0.039 μ F 50V	マイラーコン	C139-142	
	UA 254470	MYLAR CAP.	0.047 μ F 50V	マイラーコン	C157. 158	
	UA 255100	MYLAR CAP.	0.1 μ F 50V	マイラーコン	C222	
	UA 255220	MYLAR CAP.	0.22 μ F 50V	マイラーコン	C159. 160	
	UW 817330	ELECTROLYTIC CAP.	33 μ F 6.3V	ケミコン	C217	
	UW 817470	ELECTROLYTIC CAP.	47 μ F 6.3V	ケミコン	C147. 148. 161. 162	
	UW 818220	ELECTROLYTIC CAP.	220 μ F 6.3V	ケミコン	C111. 112	
	UW 828100	ELECTROLYTIC CAP.	100 μ F 10V	ケミコン	C109. 110	
	UW 937220	ELECTROLYTIC CAP.	22 μ F 16V	ケミコン	C225	
	UW 839100	ELECTROLYTIC CAP.	1000 μ F 16V	ケミコン	C211. 212	
	UW 948100	ELECTROLYTIC CAP.	100 μ F 25V	ケミコン	C223. 224	
	UW 565220	ELECTROLYTIC CAP.	0.22 μ F 50V	ケミコン	C193-196 183. 184	
	UW 965470	ELECTROLYTIC CAP.	0.47 μ F 50V	ケミコン	C179. 180 197-200	
	UW 867100	ELECTROLYTIC CAP.	10 μ F 50V	ケミコン	C181. 182	
	UW 868220	ELECTROLYTIC CAP.	220 μ F 50V	ケミコン	C177. 178	
	UW 678100	ELECTROLYTIC CAP.	100 μ F 63V	ケミコン	C216	
*	FZ 004420	POLYPROPYLENE CAPACITOR	0.047pF 100V	ポリプロコン	C218. 219	G. GB

* : New Parts (新規部品)

IPARTS LIST(ELECTRICITY)

EF. IO.	PARTS NO.	DESCRIPTION	部 品 名	REMARKS	MARKET	
	GD900480	COIL	1.7 μ H	コイル	L105.106	
	GE900330	FERRITE SHEILD TYPE CHOKE COIL	220 μ H	チョークコイル	L103.104	G. GB
	GE900840	FERRITE SHEILD TYPE CHOKE COIL	15 μ H	チョークコイル	L101.102	G. GB
	HJ353470	CARBON RESISTOR	4.7 Ω	カーボン抵抗	R279	G. GB
	HJ353470	CARBON RESISTOR	4.7 Ω	カーボン抵抗	R183.184	
	HJ354100	CARBON RESISTOR	10 Ω	カーボン抵抗	R125.126 251-256	
	HJ354220	CARBON RESISTOR	22 Ω	カーボン抵抗	R169-172.277	
	HJ354100	CARBON RESISTOR	10 Ω	カーボン抵抗	R101.102	J. R. U. A. G. C. B
	HJ354330	CARBON RESISTOR	33 Ω	カーボン抵抗	R101.102	G. GB
	HJ354330	CARBON RESISTOR	33 Ω	カーボン抵抗	R109.110	U. A. A. B. R
	HJ356220	CARBON RESISTOR	2.7K Ω	カーボン抵抗	R109.110	G. GB
	HJ355100	CARBON RESISTOR	100 Ω	カーボン抵抗	R105.106.135.136.175.176	
	HJ355150	CARBON RESISTOR	150 Ω	カーボン抵抗	R123.124.221.224	
	HJ355180	CARBON RESISTOR	180 Ω	カーボン抵抗	R191.192	
	HJ355470	CARBON RESISTOR	470 Ω	カーボン抵抗	R139.140.195.196.187-290	
	HJ355470	CARBON RESISTOR	470 Ω	カーボン抵抗	R103.104	G. GB
	HJ355560	CARBON RESISTOR	560 Ω	カーボン抵抗	R117.118	
	HJ356100	CARBON RESISTOR	1K Ω	カーボン抵抗	R167.168.187.188	
	HJ356120	CARBON RESISTOR	1.2K Ω	カーボン抵抗	R219.220.203.204	
	HJ356150	CARBON RESISTOR	1.5K Ω	カーボン抵抗	R181.182	
	HJ356220	CARBON RESISTOR	2.2K Ω	カーボン抵抗	R262.263.229-232.193.194 R199.200.209.210.264.265	
	HJ356270	CARBON RESISTOR	2.7K Ω	カーボン抵抗	R205.-208	
	HV356270	FLAME PROOF CARBON RESISTOR	2.7K Ω	不燃化カーボン抵抗	R205-208	
	HJ356470	CARBON RESISTOR	4.7K Ω	カーボン抵抗	R111-116.155.156.243.244	
	HJ356560	CARBON RESISTOR	5.6K Ω	カーボン抵抗	R153.154.177-180	
	HJ356688	CARBON RESISTOR	6.8K Ω	カーボン抵抗	R133.134.173.174.213.214	
	HJ356820	CARBON RESISTOR	8.2K Ω	カーボン抵抗	R127.128.137.138. R161.162.225.228	
	HJ357100	CARBON RESISTOR	10K Ω	カーボン抵抗	R197.198.215.218. R259.294	
	HJ357120	CARBON RESISTOR	12K Ω	カーボン抵抗	R260.261	
	HJ357150	CARBON RESISTOR	15K Ω	カーボン抵抗	R249.250	
	HJ357220	CARBON RESISTOR	22K Ω	カーボン抵抗	R119-122.157.158	
	HJ357390	CARBON RESISTOR	39K Ω	カーボン抵抗	R245.246	
	HJ357430	CARBON RESISTOR	43K Ω	カーボン抵抗	R185.186	
	HJ357470	CARBON RESISTOR	47K Ω	カーボン抵抗	R107.108.151.152.266	
	HJ357680	CARBON RESISTOR	68K Ω	カーボン抵抗	R278	
	HJ357820	CARBON RESISTOR	82K Ω	カーボン抵抗	R131.132	
	HJ358100	CARBON RESISTOR	100K Ω	カーボン抵抗	R275.276.281.211 R212.285.286	
	HJ358150	CARBON RESISTOR	150K Ω	カーボン抵抗	R159.160.163.164	
	HJ358220	CARBON RESISTOR	220K Ω	カーボン抵抗	R273.280	
	HJ358390	CARBON RESISTOR	390K Ω	カーボン抵抗	R165.166	
	HJ358470	CARBON RESISTOR	470K Ω	カーボン抵抗	R268-272.274	
	HJ359100	CARBON RESISTOR	1M Ω	カーボン抵抗	R129.130	
	HJ359220	CARBON RESISTOR	2.2M Ω	カーボン抵抗	R267	
	HL725270	METAL OXIDE FILM RESISTOR	2P 270 Ω	酸化抵抗	R283.284	
	HL326150	METAL OXIDE FILM RESISTOR	2P 1.5K Ω	酸化抵抗	R257.258.	
	HL326180	METAL OXIDE FILM RESISTOR	2P 1.8K Ω	酸化抵抗	R201.202	
	HL836120	METAL OXIDE FILM RESISTOR	3P 1.2K Ω	酸化抵抗	R282	
	HL836120	METAL OXIDE FILM RESISTOR	3P 1.2K Ω	酸化抵抗	R291	U. C
	HS311890	VARIABLE RESISTOR	100KA \times 2	VR16型 1軸2連	VR103	

: New Parts (新規部品)

■ PARTS LIST (ELECTRICITY)

REF. NO.	PARTS NO.	DESCRIPTION	部 品 名	REMARKS	MARKET	
※	HS 311900	VARIABLE RESISTOR	300HB×2	VR16型 1軸2連	VR102	
※	HS 311910	VARIABLE RESISTOR	200KB×2	VR16型 1軸2連	VR101	
※	HS 311920	VARIABLE RESISTOR	400K特×2	VR16型 1軸2連	VR104	
※	HS 311930	VARIABLE RESISTOR	100K特×2	VR16型 1軸2連	VR105	
	HT 370070	VARIABLE RESISTOR	B3K	半固定VR V8K4-1	V107. 108	
	HV353220	FLAME PROOF RESISTOR	2.2Ω	不燃化カーボン抵抗	R233. 234	
	HV354100	FLAME PROOF RESISTOR	10Ω	不燃化カーボン抵抗	R293	
	HV354220	FLAME PROOF RESISTOR	22Ω	不燃化カーボン抵抗	R189. 190	
	HV355470	FLAME PROOF RESISTOR	470Ω	不燃化カーボン抵抗	R235. 236	
	HZ 002260	METAL PLATE RESISTOR	0.1Ω 5P	金属板抵抗	R247. 248	
	HZ 002390	METAL PLATE RESISTOR	0.22Ω 3P	金属板抵抗	R239. 242	
	HZ 003050	METAL PLATE RESISTOR	0.22Ω 3P	金属板抵抗	R240. 241	
	IA 099910	TRANSISTOR	2SA999	トランジスタ	TR115~118	
	IA 101100	TRANSISTOR	2SA1011	トランジスタ	TR121. 122	
	IA 120900	TRANSISTOR	2SA1209	トランジスタ	TR113. 114	
	IC 232010	TRANSISTOR	2SC2320	トランジスタ E.F	TR107~112	
	IC 234400	TRANSISTOR	2SC2344	トランジスタ D.E	TR119. 120	
	IE 102710	DUAL FET	2SK270	デュアルFET	TR101. 102	
※	IE 103410	FET	2SK117	FET	TR103~106	
	IF 000040	DIODE	1S1555	ダイオード	D101. 102	
	IF 000670	DIODE	1S2473	ダイオード	D101. 102	
	IF 001380	DIODE	1SS84	ダイオード	D108	
	IF 001400	DIODE	1SS82	ダイオード	D103. 104	
	IF 002080	ZENER DIODE	HZ16L-3	ツェナーダイオード	D109~111	
※	IF 004270	LED		LED (RED)	D112. 113	
※	IF 004280	LED		LED (GREEN)	D114~119	
※	IG 085700	IC	M5218L	IC	IC101. 102	
	IH 000870	DIODE BRIDGE	4D4B41	ダイオードブリッジ	D107	
	IH 001040	DIODE BRIDGE	RB402 (LFA)	ダイオードブリッジ	D107	
	IH 001170	DIODE BRIDGE	D4BB20	ダイオードブリッジ	D107	
※	KA 803520	PUSH SWITCH	SDL	プッシュSW	SW108	J. R. RB
※	KA 803570	PUSH SWITCH	2CIRCUIT2	プッシュSW	SW107	
※	KA 802820	PUSH SWITCH		プッシュSW	SW105. 106	
※	KA 803500	PUSH SWITCH	6CIRCUIT2	プッシュSW	SW101	
※	KA 803510	PUSH SWITCH	4CIRCUIT2	プッシュSW	SW104	
※	KA 803360	PUSH SWITCH	4CIRCUIT2	プッシュSW	SW103	
※	KA 501810	ROTARY SWITCH	I=20	ロータリーSW	SW102	
	KB 000370	FUSE	3.5A 250V	タイラッシュヒューズ	F102	R. RB
	KB 001300	FUSE	7.0A 250V	タイラッシュヒューズ	F101	J. R. RB
	KB 000760	FUSE	3.15A 250V	タイムラグヒューズ	F101	A. G. B. GB
	KB 001520	FUSE	7A 125V	ULタイムラグヒューズ	F101	U. C
	KC 001150	RELAY	DC24V	リレー	RY101	U. C
※	KC 001460	RELAY		リレー	RY101	J. R. A. G. B. RB. GB
※	LB 301750	PHONES JACK		ホーンジャック	TK101	J. R. U. A. G. C. B
※	LB 301760	PHONES JACK		ホーンジャック	TK101 (BLACK)	RB. GB
※	LB 401030	PIN JACK 4P		4Pピンジャック	PJ102~104	
※	LB 401050	PIN JACK 4P		4Pピンジャック	PJ101	
	LB 002140	WRAPPING TERMINAL (1 TYPE) P=10 2P	P=10 2P	I型ラッピング端子板		R. U. A. G. C. B. RB. GB
	LA 002150	WRAPPING TERMINAL (1 TYPE) P=10 3P	P=10 3P	I型ラッピング端子板		

※ : New Parts (新規部品)

